

Profilo in alluminio singolo esterno da avvitare; fori svasati, vite TSP Ø 3 ARGENTO

CODICE 1003235111A

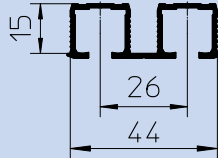

Profilo in alluminio doppio, passo 26, da incasso, da avvitare o incollare; fori svasati, TSP Ø 3 ARGENTO

CODICE 1003235102A

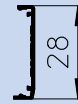

Profilo in alluminio copertura per minipinze vetro ARGENTO

CODICE 1003235123A



Carrello completo di viti inox

CODICE 10032035023



Fermo fine corsa con regolazione forza

CODICE 10032035002



Carrello decelerato con attivatore

COD. 10032035015L Kg 10

COD. 10032035015M Kg 20

COD. 10032035015F Kg 30



Guida inferiore per vetro in zama con riduzioni 6÷8

CODICE 10032035011



Minipinza vetro completa di viteria inox

CODICE 10032035022



Tappi di copertura laterali dx-sx

CODICE 10032035024



Carrello Colibri decelerato con minipinza vetro e attivatore

COD. 10032035031L Kg 10

COD. 10032035031M Kg 20

COD. 10032035031F Kg 30

ESEMPIO DI MONTAGGIO KIT SENZA DECELERATORE

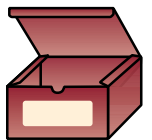
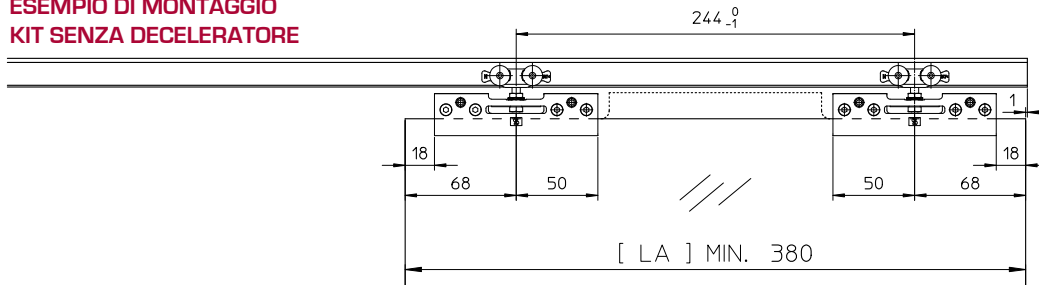

CODICE 10032035307

ESEMPIO DI MONTAGGIO KIT CON UN DECELERATORE

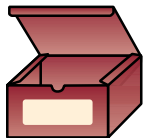
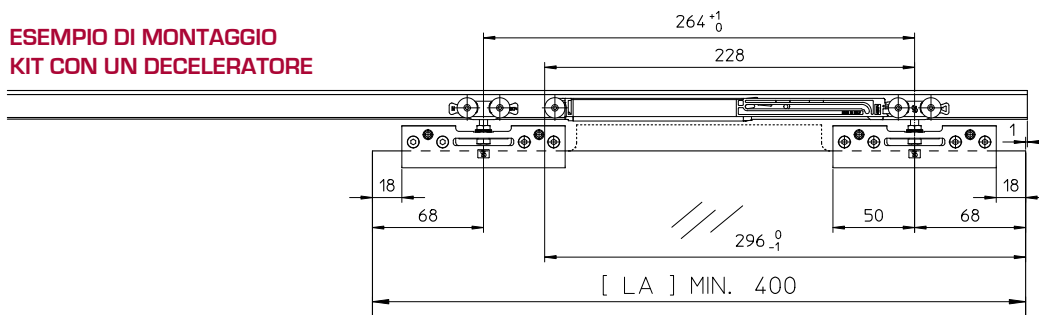

CODICE 10032035314

ESEMPIO DI MONTAGGIO KIT CON DUE DECELERATORI

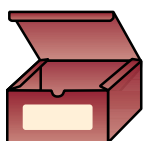
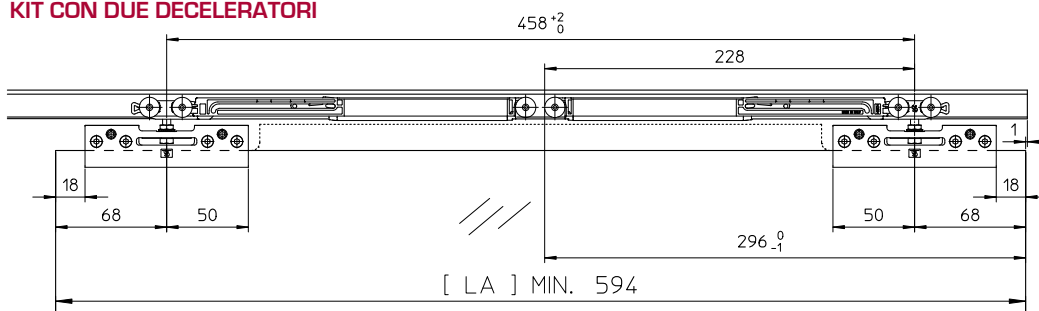

CODICE 10032035315