

GRIGLIE TONDE UNIVERSALI CON MOLLE

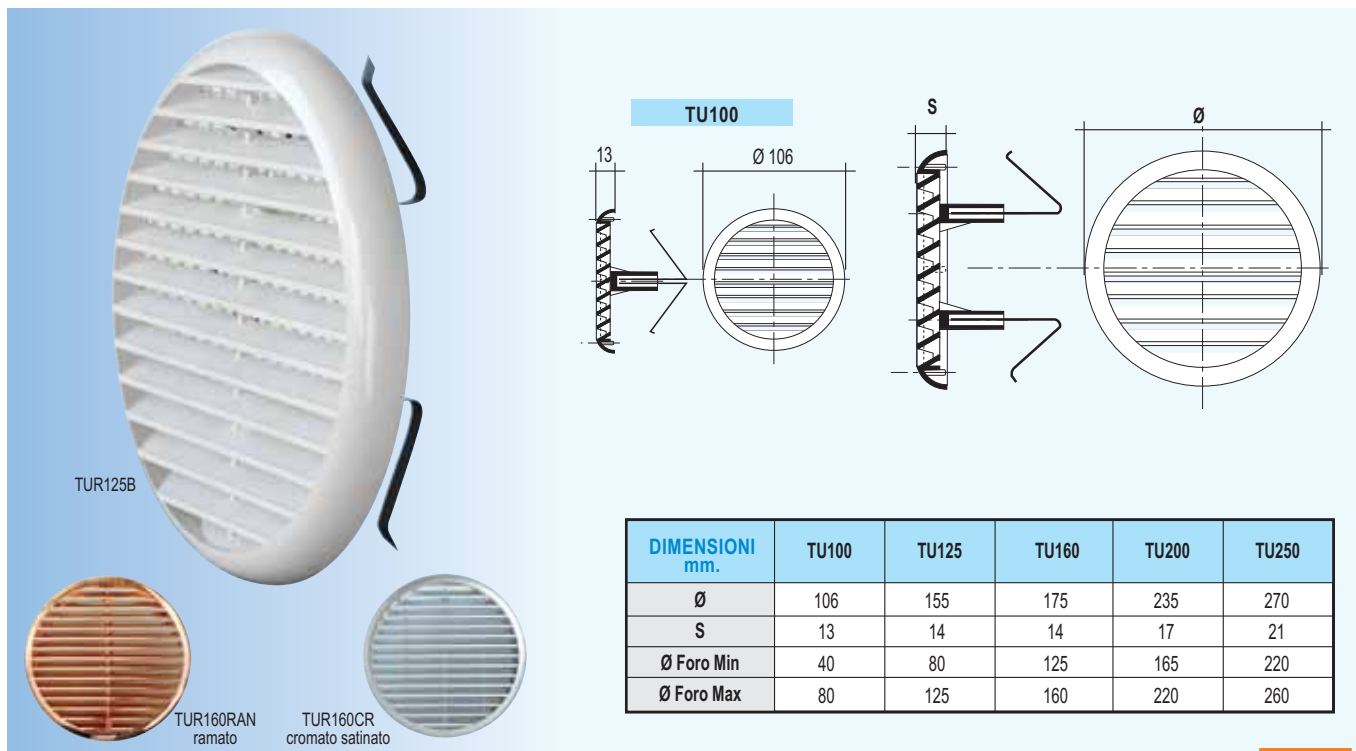

DIMENSIONI mm.	TU100	TU125	TU160	TU200	TU250
Ø	106	155	175	235	270
S	13	14	14	17	21
Ø Foro Min	40	80	125	165	220
Ø Foro Max	80	125	160	220	260

LINEA BLISTER



FORO Griglia	Dim. mm	PASS AIR cm ²		COLORE	CODICE	CODICE Blister	
 senza rete	Ø 106	40	24/60	bianco marrone cromato satin. ramato	TU100B TU100M TU100CR TU100RAN	TU100X TU100W TU100CRQ TU100RANQ	6 12
	 con rete	Ø 106	40	24/60	bianco marrone cromato satin. ramato	TUR100B TUR100M TUR100CR TUR100RAN	TUR100X TUR100W TUR100CRQ TUR100RANQ
 senza rete	Ø 155	100 con foro Ø 121	24/96	bianco marrone cromato satin. ramato	TU125B TU125M TU125CR TU125RAN	TU125X TU125W TU125CRQ TU125RANQ	36 12
	 con rete	Ø 155	100 con foro Ø 121	24/96	bianco marrone sabbia cromato satin. ramato	TUR125B TUR125M TUR125S TUR125CR TUR125RAN	TUR125X TUR125W TUR125CRQ TUR125RANQ
 senza rete	Ø 175	135 con foro Ø 157	24/102	bianco marrone cromato satin. ramato	TU160B TU160M TU160CR TU160RAN	TU160X TU160W TU160CRQ TU160RANQ	12
	 con rete	Ø 175	135 con foro Ø 157	24/102	bianco marrone sabbia cromato satin. ramato	TUR160B TUR160M TUR160S TUR160CR TUR160RAN	TUR160X TUR160W TUR160CRQ TUR160RANQ

GRIGLIE TONDE UNIVERSALI CON MOLLE

LINEA BLISTER



FORO Griglia	Dim. mm	PASS AIR cm ²		COLORE	CODICE	CODICE Blister	
	senza rete	Ø 235 220 con foro Ø 198	12/36	bianco marrone cromato satin. ramato	TU200B TU200M TU200CR TU200RAN	TU200X TU200W TU200CRQ TU200RANQ	12
	con rete	Ø 235 200 con foro Ø 198	12/36	bianco marrone cromato satin. ramato	TUR200B TUR200M TUR200CR TUR200RAN	TUR200X TUR200W TUR200CRQ TUR200RANQ	12
	senza rete	Ø 270 330	20	bianco marrone	TU250B TU250M		
	con rete	Ø 270 210	20	bianco marrone	TUR250B TUR250M		

GRIGLIE TONDE UNIVERSALI CON MOLLE AD ALETTE DIRITTE



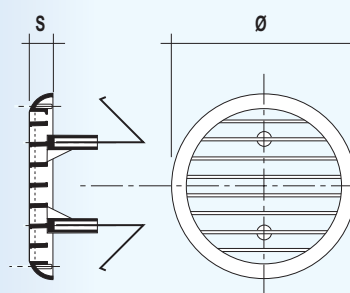

DIMENSIONI mm.	TUO125	TUO160	TUO200
Ø	135	175	235
S	14	14	17
Ø Foro Min	80	125	165
Ø Foro Max	125	160	220

LINEA BLISTER



FORO Griglia	Dim. mm	PASS AIR cm ²		COLORE	CODICE	CODICE Blister	
	senza rete	Ø 135 115 con foro Ø 121	24/96	bianco marrone	TUO125B TUO125M	TUO125X	12
	con rete	Ø 135 100 con foro Ø 121	24/96	bianco marrone	TUOR125B TUOR125M	TUOR125X	12
	senza rete	Ø 175 150 con foro Ø 157	24/102	bianco marrone	TUO160B TUO160M	TUO160X	12
	con rete	Ø 175 135 con foro Ø 157	24/102	bianco marrone	TUOR160B TUOR160M	TUOR160X	12
	senza rete	Ø 235 255 con foro Ø 198	12/36	bianco marrone	TUO200B TUO200M	TUO200X	6
	con rete	Ø 235 200 con foro Ø 198	12/36	bianco marrone	TUOR200B TUOR200M	TUOR200X	6

GRIGLIE TONDE DA INCASSO

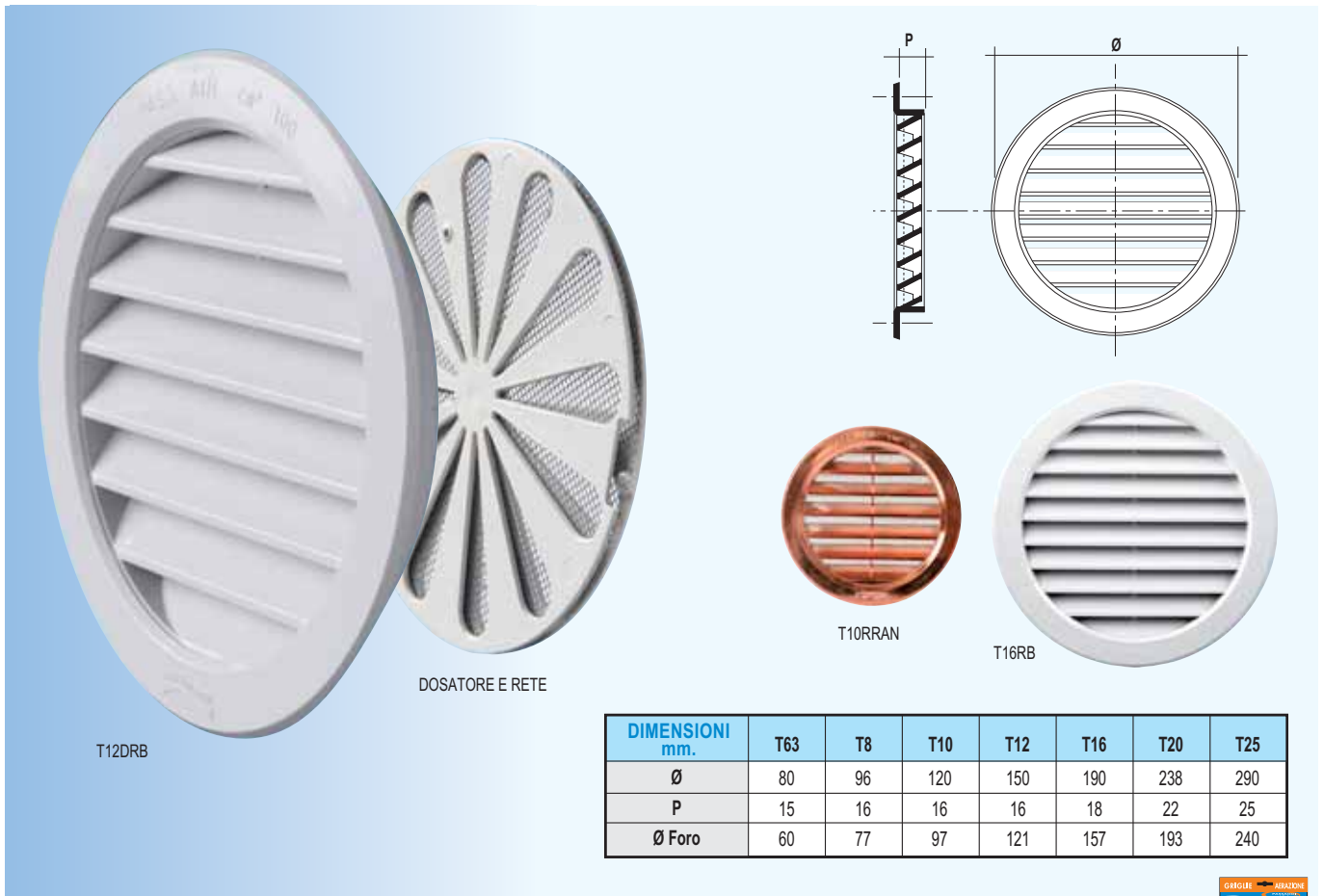

DIMENSIONI mm.	T63	T8	T10	T12	T16	T20	T25
Ø	80	96	120	150	190	238	290
P	15	16	16	16	18	22	25
Ø Foro	60	77	97	121	157	193	240



LINEA BLISTER

GRIGLIA	Dim. mm	Foro mm	PASS AIR cm ²		COLORE	CODICE		CODICE Blister		
	senza rete	Ø 80	Ø 60	20	60/120	bianco marrone	T63B T63M			
	con rete	Ø 80	Ø 60	20	60/120	bianco marrone	T63RB T63RM	T63RX T63RW	24	
	senza rete	Ø 96	Ø 77	50	30/180	bianco marrone	T8B T8M			
	con rete	Ø 96	Ø 77	50	30/180	bianco marrone ramato	T8RB T8RM T8RRAN	T8RX T8RW T8RRANQ	24	
	con dosatore	Ø 96	Ø 77	25	30/180	bianco marrone	T8DB T8DM			
	con dosatore e rete	Ø 96	Ø 77	25	30/180	bianco marrone	T8DRB T8DRM	T8DRX T8DRW	24	
	con dosatore e funicelle	Ø 96	Ø 77	25	30/180	bianco marrone	T8DSB T8DSM			
	con dosatore, rete e funicelle	Ø 96	Ø 77	25	30/180	bianco marrone	T8DSRB T8DSRM			

GRIGLIE TONDE DA INCASSO

LINEA BLISTER



GRIGLIE IN
PLASTICA











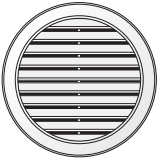

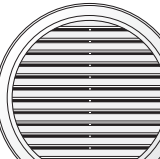

GRIGLIA	Dim. mm	Foro mm	PASS AIR cm ²		COLORE	CODICE		CODICE Blister		
senza rete	Ø 120	Ø 97	70	20/100	bianco	T10B				
					marrone	T10M				
con rete	Ø 120	Ø 97	70	20/100	bianco	T10RB		T10RX	24	
					marrone	T10RM		T10RW		
					sabbia	T10RS				
					ramato	T10RRAN		T10RRANQ	24	
con dosatore	Ø 120	Ø 97	35	20/100	bianco	T10DB				
					marrone	T10DM				
con dosatore e rete	Ø 120	Ø 97	35	20/100	bianco	T10DRB		T10DRX	24	
					marrone	T10DRM		T10DRW		
con dosatore e funicelle	Ø 120	Ø 97	35	20/100	bianco	T10DSB				
					marrone	T10DSM				
con dosatore, rete e funicelle	Ø 120	Ø 97	35	20/100	bianco	T10DSRB				
					marrone	T10DSRM				
senza rete	Ø 150	Ø 121	100	20/120	bianco	T12B				
					marrone	T12M				
con rete	Ø 150	Ø 121	100	20/120	bianco	T12RB		T12RX	36	
					marrone	T12RM		T12RW		
					sabbia	T12RS				
					ramato	T12RRAN		T12RRANQ	36	
con dosatore	Ø 150	Ø 121	50	20/120	bianco	T12DB				
					marrone	T12DM				
con dosatore e rete	Ø 150	Ø 121	50	20/120	bianco	T12DRB		T12DRX	36	
					marrone	T12DRM		T12DRW		
con dosatore e funicelle	Ø 150	Ø 121	50	20/120	bianco	T12DSB				
					marrone	T12DSM				
con dosatore, rete e funicelle	Ø 150	Ø 121	50	20/120	bianco	T12DSRB				
					marrone	T12DSRM				

GRIGLIE TONDE DA INCASSO

GRIGLIE TONDE DA INCASSO

LINEA BLISTER

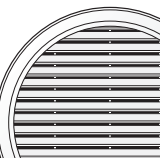

GRIGLIA	Dim. mm	Foro mm	PASS AIR cm ²		COLORE	CODICE		CODICE Blister		
	senza rete	Ø 190	Ø 157	135	40	<div style="border: 1px solid black; padding: 2px;">bianco</div> <div style="border: 1px solid black; padding: 2px;">marrone</div>	T16B T16M			
	 con rete	Ø 190	Ø 157	135	40	<div style="border: 1px solid black; padding: 2px;">bianco</div> <div style="border: 1px solid black; padding: 2px;">marrone</div> <div style="border: 1px solid black; padding: 2px;">ramato</div>	T16RB T16RM T16RRAN	T16RX T16RW T16RRANQ	24	
	 con dosatore	Ø 190	Ø 157	70	40	<div style="border: 1px solid black; padding: 2px;">bianco</div> <div style="border: 1px solid black; padding: 2px;">marrone</div>	T16DB T16DM			
	 con dosatore e rete	Ø 190	Ø 157	70	40	<div style="border: 1px solid black; padding: 2px;">bianco</div> <div style="border: 1px solid black; padding: 2px;">marrone</div>	T16DRB T16DRM	T16DRX T16DRW	24	
	 con dosatore e funicelle	Ø 190	Ø 157	70	40	<div style="border: 1px solid black; padding: 2px;">bianco</div> <div style="border: 1px solid black; padding: 2px;">marrone</div>	T16DSB T16DSM			
	 con dosatore, rete e funicelle	Ø 190	Ø 157	70	40	<div style="border: 1px solid black; padding: 2px;">bianco</div> <div style="border: 1px solid black; padding: 2px;">marrone</div>	T16DSRB T16DSRM			
	senza rete	Ø 238	Ø 193	240	24	<div style="border: 1px solid black; padding: 2px;">bianco</div> <div style="border: 1px solid black; padding: 2px;">marrone</div>	T20B T20M			
	 con rete	Ø 238	Ø 193	220	24	<div style="border: 1px solid black; padding: 2px;">bianco</div> <div style="border: 1px solid black; padding: 2px;">marrone</div>	T20RB T20RM	T20RX T20RW	24	
	 con dosatore	Ø 238	Ø 193	120	24	<div style="border: 1px solid black; padding: 2px;">bianco</div> <div style="border: 1px solid black; padding: 2px;">marrone</div>	T20DB T20DM			
	 con dosatore e rete	Ø 238	Ø 193	120	24	<div style="border: 1px solid black; padding: 2px;">bianco</div> <div style="border: 1px solid black; padding: 2px;">marrone</div>	T20DRB T20DRM	T20DRX T20DRW	24	
	 con dosatore e funicelle	Ø 238	Ø 193	110	24	<div style="border: 1px solid black; padding: 2px;">bianco</div> <div style="border: 1px solid black; padding: 2px;">marrone</div>	T20DSB T20DSM			
	 con dosatore, rete e funicelle	Ø 238	Ø 193	110	24	<div style="border: 1px solid black; padding: 2px;">bianco</div> <div style="border: 1px solid black; padding: 2px;">marrone</div>	T20DSRB T20DSRM			
	senza rete	Ø 290	Ø 240	330	10/30	<div style="border: 1px solid black; padding: 2px;">bianco</div> <div style="border: 1px solid black; padding: 2px;">marrone</div>	T25B T25M			
	 con rete	Ø 290	Ø 240	260	10/30	<div style="border: 1px solid black; padding: 2px;">bianco</div> <div style="border: 1px solid black; padding: 2px;">marrone</div>	T25RB T25RM			

GRIGLIE TELESCOPICHE

GRIGLIA P/TELESCOPICA

Griglia per porte e pannelli. Per il fissaggio occorre accoppiare le due griglie ed avvitarle con le viti in dotazione fino alla misura desiderata. Si evita così di praticare fori per le viti nella porta.

PT489

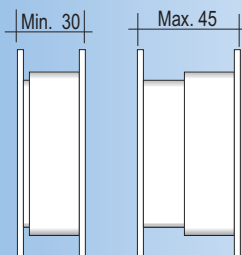

PTT459

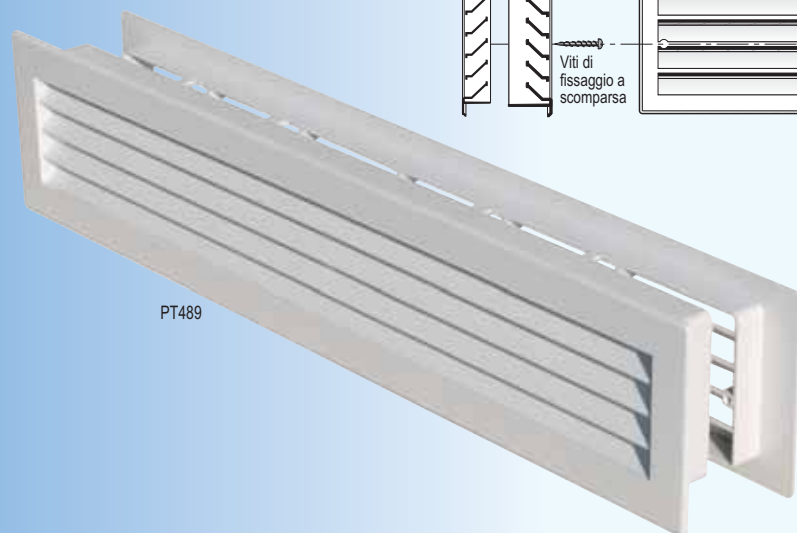
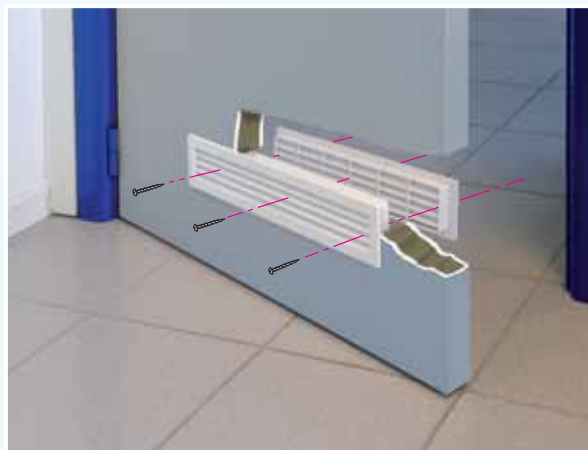
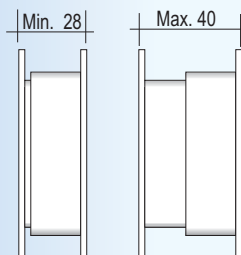

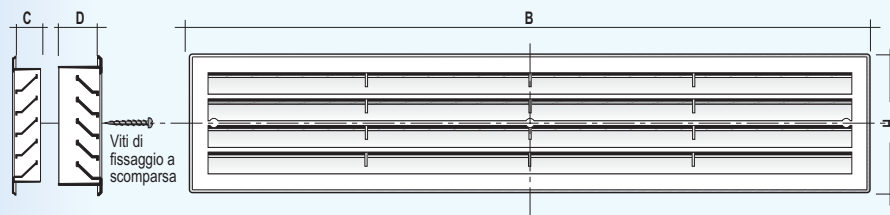

PT489



DIMENSIONI mm.	PT489	PTT459
B x H	480x98	452x90
Foro (BxH)	448x82	433x78
C	18	17
D	32	30
Spessore min.	30	28
Spessore max.	45	40

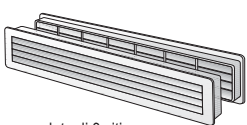
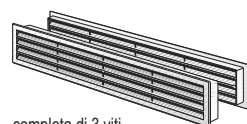

LINEA BLISTER

GRIGLIA	Dim. mm	Foro mm	PASS AIR		COLORE	CODICE		CODICE Blister			
 completa di 3 viti	480x98	448x82	250	15/30	bianco	PT489B		PT489X	6		
					marrone	PT489M					
					nero	PT489N					
 completa di 3 viti	452x90	433x78	200	15/30	bianco	PTT459B		PTT459X	6		
					marrone	PTT459M					
					nero	PTT459N					
	 completa di 3 viti con dosatore	452x90	433x78	140	15/30	bianco	PTTD459B		PTTD459X	6	
						marrone	PTTD459M				
						nero	PTTD459N				

GRIGLIE TIPO 'P' DA INCASSO

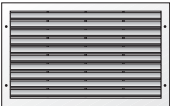

LINEA BLISTER

GRIGLIA	Dim. mm	Foro mm	PASS AIR cm ²		COLORE	CODICE		CODICE Blister		
	senza rete	315x136	275x96	145	30/60	bianco marrone nero	P3113B P3113M P3113N			
	con rete	315x136	275x96	130	30/60	bianco marrone nero	P31R13B P31R13M P31R13N			
	senza rete	515x60	493x40	63	30/60	bianco marrone nero	P51516B P51516M P51516N			
	con rete	515x60	493x40	55	30/60	bianco marrone nero	P51R516B P51R516M P51R516N	P51R516X P51R516W P51R516H	6	
	senza rete	370x130	336x96	140	30/60	bianco marrone nero	P3713B P3713M P3713N			
	con rete	370x130	336x96	85	30/60	bianco marrone nero	PR3713B PR3713M PR3713N	PR3713X PR3713W PR3713H	12	
	con dosatore	370x130	336x96	115	30/60	bianco marrone nero	PD3713B PD3713M PD3713N			
	dosatore e rete	370x130	336x96	60	30/60	bianco marrone nero	PDR3713B PDR3713M PDR3713N	PDR3713X PDR3713W PDR3713H	6	
	senza rete	380x230	335x190	315	30	bianco marrone nero	PA3823B PA3823M PA3823N			
	con rete	380x230	335x190	175	30	bianco marrone nero	PAR3823B PAR3823M PAR3823N	PAR3823X PAR3823W PAR3823H	6	
	con dosatore	380x230	335x190	255	30	bianco marrone nero	PAD3823B PAD3823M PAD3823N			
	dosatore e rete	380x230	335x190	110	30	bianco marrone nero	PADR3823B PADR3823M PADR3823N	PADR3823X PADR3823W PADR3823H	6	