

SYSTEM 0400/40

Sistema scorrevole per porte in legno
 Sistema corredero para puertas de madera
 Système coulissant pour portes en bois

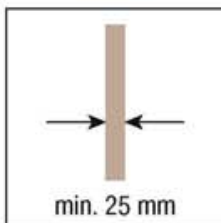
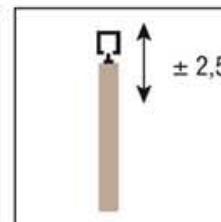
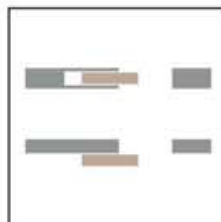

KIT Art. 0400 3	
Carrello di scorrimento 40kg Carro de deslizamiento 40kg Chariot de coulissement 40kg	 2 pcs
Staffa ancoraggio porta Soporte anclaje puerta Etrier d'ancrage de porte	 2 pcs
Vite supporto carrello Tornillo de soporte carro Vis de support du chariot	 2 pcs
Guida inferiore Guiador inferior Glissière inférieure	 1 pcs
Freno d'arresto Freno tope Frein de blocage	 2 pcs

KIT Art. 040040 150	
Porte - Puertas - Portes : 71÷90	
KIT (Art. 0400 3) + binario mm 1.500 KIT (Art. 0400 3) + guía mm 1.500 KIT (Art. 0400 3) + rail mm 1.500	
KIT Art. 040040 190	
Porte - Puertas - Portes : 91÷120	
KIT (Art. 0400 3) + binario mm 1.900 KIT (Art. 0400 3) + guía mm 1.900 KIT (Art. 0400 3) + rail mm 1.900	
KIT Art. 040040 230	
Porte - Puertas - Portes : 121÷150	
KIT (Art. 0400 3) + binario mm 2.300 KIT (Art. 0400 3) + guía mm 2.300 KIT (Art. 0400 3) + rail mm 2.300	
KIT Art. 040040 300	
Porte - Puertas - Portes : 151÷180	
KIT (Art. 0400 3) + binario mm 3.000 KIT (Art. 0400 3) + guía mm 3.000 KIT (Art. 0400 3) + rail mm 3.000	

*Ricambi - *Repuestos - *Echanges	
Art. 0400 54 Carrello di scorrimento 40kg Carro de deslizamiento 40kg Chariot de coulissement 40kg	 2 pcs
Art. 0400 53 Staffa ancoraggio porta Soporte anclaje puerta Etrier d'ancrage de porte	 2 pcs
Art. 0400 51 Vite supporto carrello Tornillo de soporte carro Vis de support du chariot	 2 pcs
Art. 0810 80x800 Guida inferiore Guiador inferior Glissière inférieure	 1 pcs
Art. 0400 52 Freno d'arresto Freno tope Frein de blocage	 2 pcs

Accessori compatibili		
Accesorios compatibles		
Accessoires compatibles		
Art. 0400 1	m 6	
Art. 0400 1 200	m 2	
Art. 0400 1 400	m 4	
Art. 0400 6	m 3	
Binario in alluminio forato e anodizzato, portata 40 kg		
Guía en aluminio perforada y anodizada 40 kg		
Rail en aluminium anodisé et perforé, portée 40 kg		
Art. 0400 1G	m 6	
Art. 0400 6G	m 3	
Binario in alluminio forato grezzo, portata 40 kg		
Guía en aluminio perforada natural 40 kg		
Rail en aluminium perforé, portée 40 kg		
Art. 0400 5		
Attacco laterale 40 kg		
Soporte de sujeción lateral 40 kg		
Fixation latérale 40 kg		

*Gli articoli presenti nella tabella "Ricambi" sono ordinabili **solo** nelle quantità indicate.

*Los artículos presentes en la tabla "Repuestos" se pueden pedir **sólo** en las cantidades indicadas.

*Les accessoires présents dans le tableau "pièces de rechanges" sont vendus **seulement** dans les quantités indiquées.

Soluzioni scorrevoli realizzabili
Soluciones correderas realizables
Solutions réalisables avec portes coulissantes

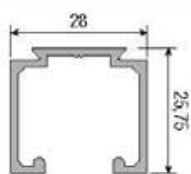
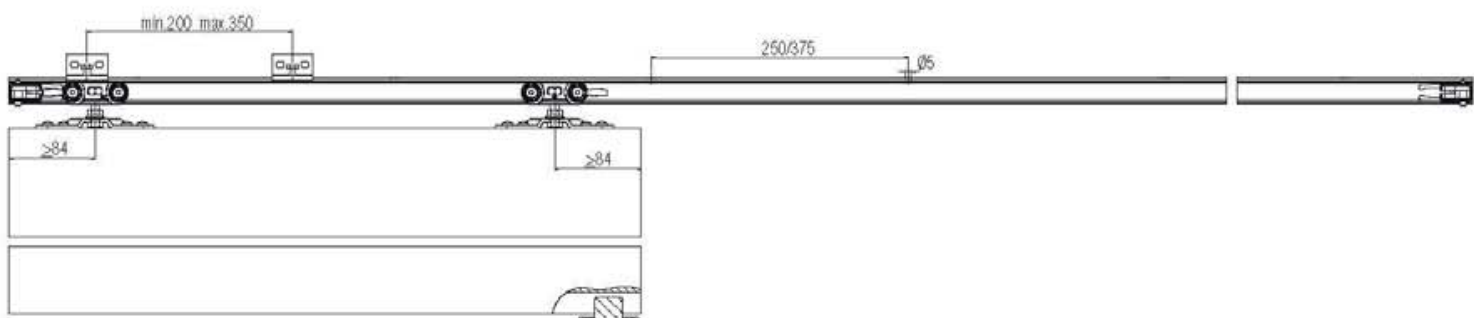
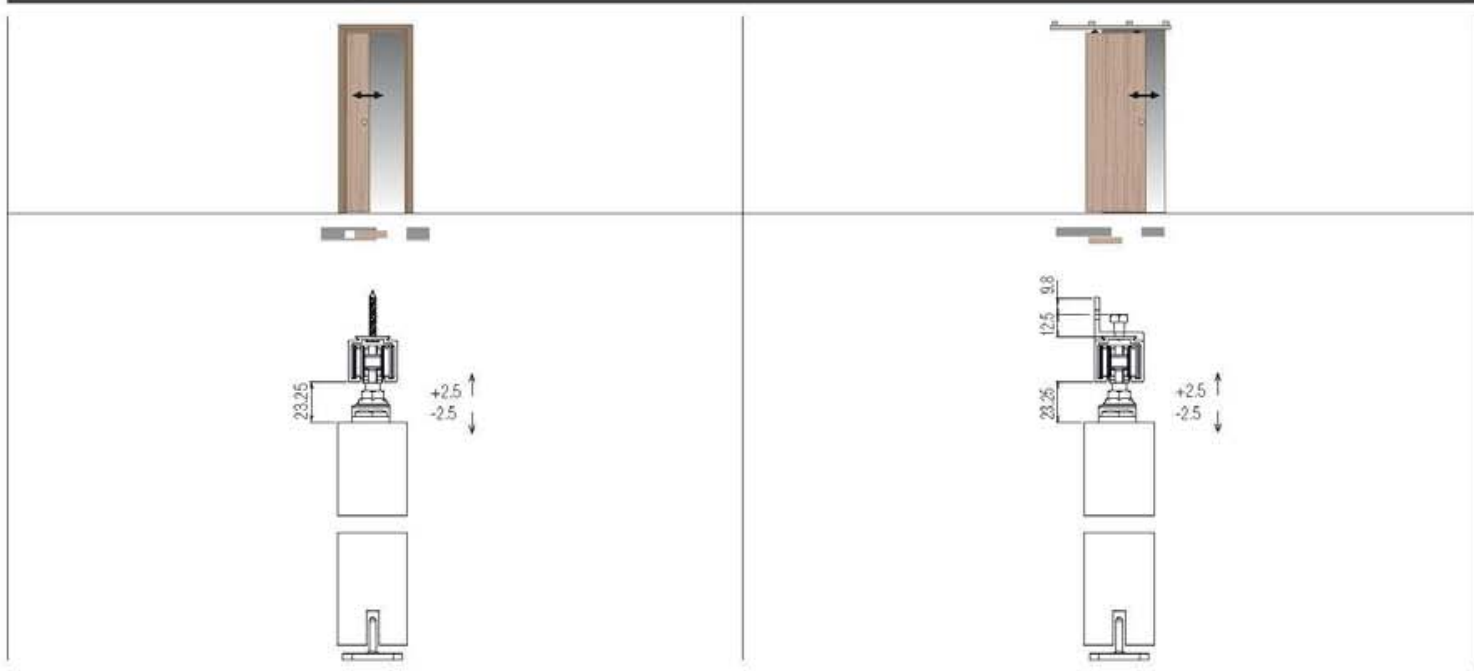

 **40 kg**

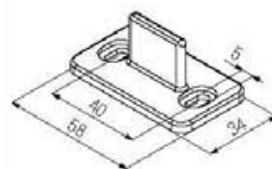
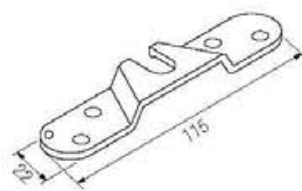

SYSTEM 0450/40

Sistema scorrevole per porte in legno a filo del binario
 Sistema corredero para puertas de madera a ras de la guía
 Système coulissant pour portes en bois ras de mur

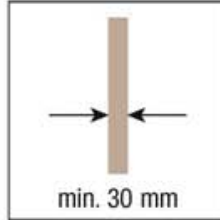
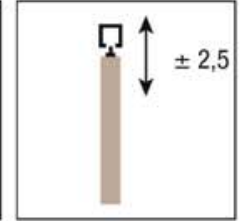
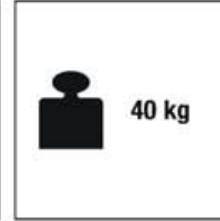

KIT Art. 0450 3	
Carrello con staffa in zama a scomparsa 40kg Carro con soporte de aguante zamac tipo retráctil 40kg Chariot avec étrier escamotable 40kg	 2 pcs
Guida inferiore Guiador inferior Glissière inférieure	 1 pcs
Freno d'arresto Freno tope Frein de blocage	 2 pcs
Chiave regolazione Llave regulación Clé de réglage du frein	 1 pcs

*Ricambi - *Repuestos - *Echanges	
Art. 0450 51 Carrello con staffa in zama a scomparsa 40kg Carro con soporte de aguante zamac tipo retráctil 40kg Chariot avec étrier escamotable 40kg	 2 pcs
Art. 0810 80x800 Guida inferiore Guiador inferior Glissière inférieure	 1 pcs
Art. 0400 52 Freno d'arresto Freno tope Frein de blocage	 2 pcs

Accessori compatibili Accesorios compatibles Accessoires compatibles	
Art. 0400 1 m 6 Art. 0400 6 m 3	
Binario in alluminio forato e anodizzato, portata 40 kg Guía en aluminio perforada y anodizada 40 kg Rail en aluminium anodisé et perforé, portée 40 kg	
Art. 0400 1G m 6 Art. 0400 6G m 3	
Binario in alluminio forato grezzo, portata 40 kg Guía en aluminio perforada natural 40 kg Rail en aluminium perforé, portée 40 kg	
Art. 0400 5 Attacco laterale 40 kg Soporte de sujeción lateral 40 kg Fixation latérale 40 kg	

*Gli articoli presenti nella tabella "Ricambi" sono ordinabili **solo** nelle quantità indicate.

*Los artículos presentes en la tabla "Repuestos" se pueden pedir **sólo** en las cantidades indicadas.

*Les accessoires présents dans le tableau "pièces de rechanges" sont vendus **seulement** dans les quantités indiquées.

Soluzioni scorrevoli realizzabili
Soluciones correderas realizables
Solutions réalisables avec portes coulissantes

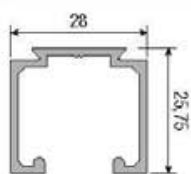
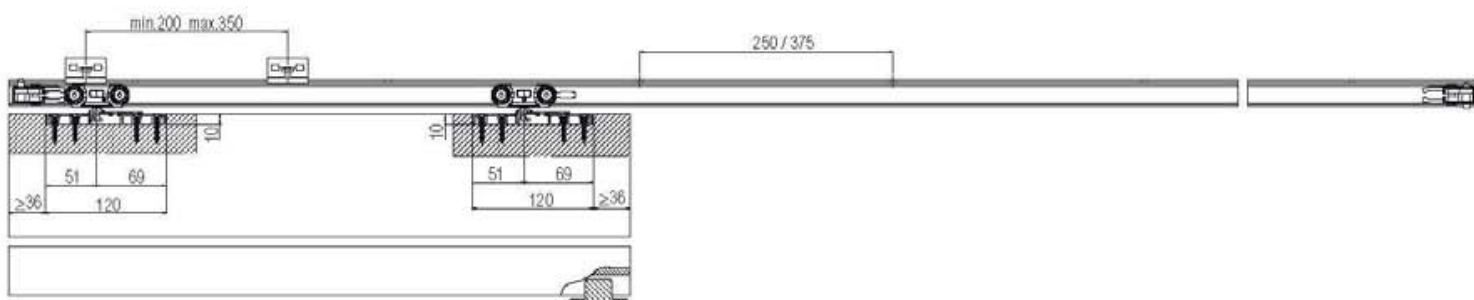
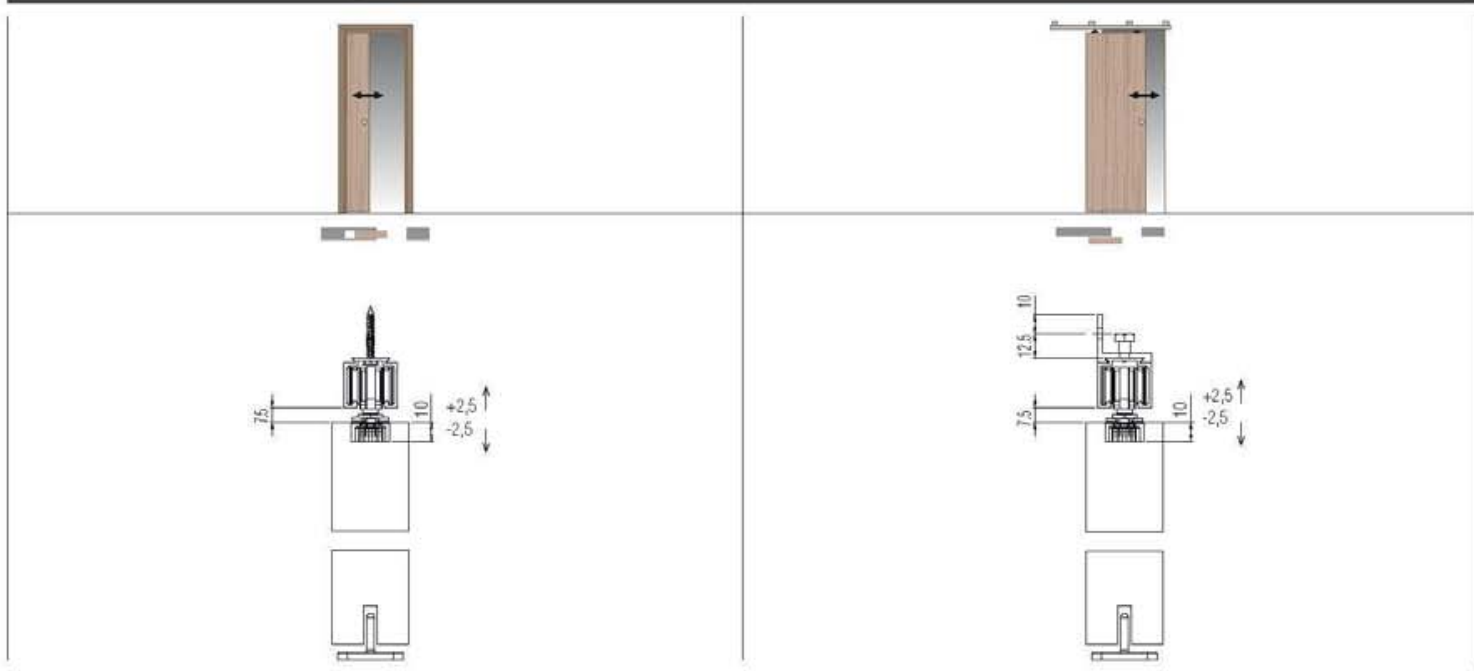

 **40 kg**

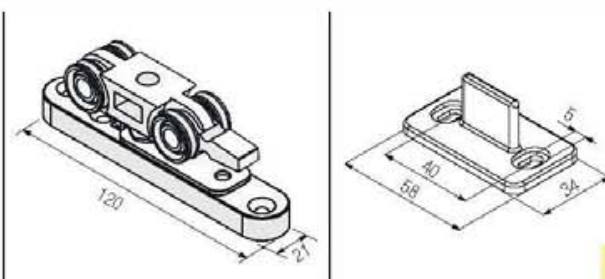

SYSTEM 0500/80/120

Sistema scorrevole per porte in legno
 Sistema corredero para puertas de madera
 Système coulissant pour portes en bois

Patented
 Patentado
 Breveté

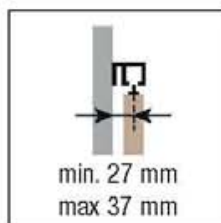
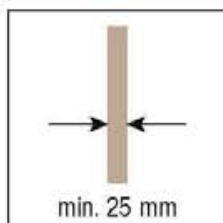
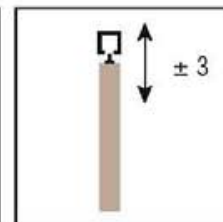
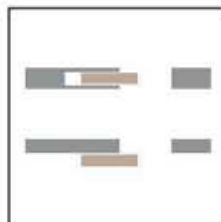
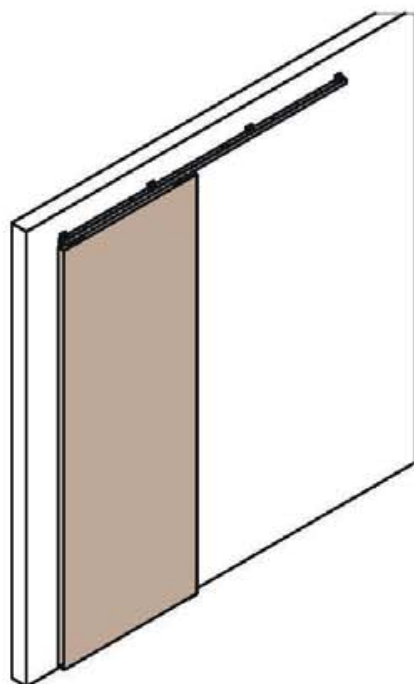

KIT Art. 0500 3	*Ricambi - *Repuestos - *Echanges	Accessori compatibili - Accesorios compatibles Accessoires compatibles	
Carrello di scorrimento 80/120kg Carro de deslizamiento 80/120kg Chariot de coulissement 80/120 kg 2 pcs	Art. 0500 52 Carrello di scorrimento 80/120kg Carro de deslizamiento 80/120kg Chariot de coulissement 80/120 kg 2 pcs	Art. 0500 1 m 6 Art. 0500 180 m 1,8 Art. 0500 200 m 2 Art. 0500 240 m 2,4 Art. 0500 300 m 3 Art. 0500 400 m 4 Binario in alluminio forato e anodizzato 60/80kg Guía en aluminio perforada y anodizada 60/80kg Rail en aluminium anodisé et perforé 60/80kg	**Art. 0500 F 200 m 2 **Art. 0500 F 300 m 3 **Art. 0500 F 400 m 4 Fissaggio a parete 60/80kg Fijación a pared 60/80 kg Fixation à la cloison 60/80 kg
Staffa doppia entrata ancoraggio porta Pletina de doble entrada de anclaje a puerta Support d'ancrage porte à double entrée 2 pcs	Art. 0500 55 Staffa doppia entrata ancoraggio porta Pletina de doble entrada de anclaje a puerta Support d'ancrage porte à double entrée 2 pcs	Art. 0500 10 m 6 Art. 0500 10 300 m 3 Binario in alluminio forato e anodizzato 120kg Guía en aluminio perforada y anodizada 120kg Rail en aluminium anodisé et perforé 120kg	**Art. 0500 F 10 m 6 **Art. 0500 F 10 300 m 3 Fissaggio a parete 120kg Fijación a pared 120 kg Fixation à la cloison 120 kg
Vite supporto carrello Tornillo de soporte carro Vis de support du chariot 2 pcs	Art. 0500 54 Vite supporto carrello Tornillo de soporte carro Vis de support du chariot 2 pcs	Art. 0500 4 Attacco laterale 60/80kg Soporte de sujeción lateral 60/80 kg Fixation latérale 60/80kg	**Art. 0500 M 200 m 2 **Art. 0500 M 300 m 3 **Art. 0500 M 400 m 4 Vetella di copertura media Tapeta de cobertura media Vollette de couverture Moyenne
Guida inferiore regolabile Guiador inferior regulable Guide inférieur réglable 1 pcs	Art. 0500 13 Guida inferiore regolabile Guiador inferior regulable Guide inférieur réglable 1 pcs	Art. 0500 5 Attacco laterale 120kg Soporte de sujeción lateral 120 kg Fixation latérale 120kg	Art. 0500 61 Chiusura laterale binario Cierre lateral guía Fermeture latérale rail 10 pcs
Freno d'arresto Freno tope Frein de blocage 2 pcs	Art. 0500 12 Freno d'arresto Freno tope Frein de blocage 2 pcs		Art. 0500 63 Chiusura laterale vetella media Cierre lateral tapeta media Fermeture latérale vollette moyenne 5+5 pcs
Chiave regolazione grano Llave regulación freno Clé de réglage du frein 1 pcs	Art. 0500 58 Piastrini di fissaggio + viti per profilo di aggancio a parete 0500 F Placas de fijación + tornillos para perfil de acoplamiento a pared 0500 F Plaque de fixation + vis pour profil de fixation au mur 0500 F 100 pcs		

*Gli articoli presenti nella tabella "Ricambi" sono ordinabili solo nelle quantità indicate.

**Non compatibile con articolo 0500 4 e 0500 5.

*Los artículos presentes en la tabla "Repuestos" se pueden pedir sólo en las cantidades indicadas.

**No compatible con artículos 0500 4 y 0500 5.

*Les accessoires présents dans le tableau "pièces de rechanges" sont vendus seulement dans les quantités indiquées.

**Non compatible avec l'article 0500 4 et 0500 5.

Soluzioni scorrevoli realizzabili
Soluciones correderas realizables
Solutions réalisables avec portes coulissantes

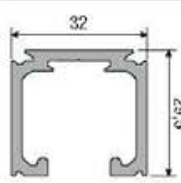
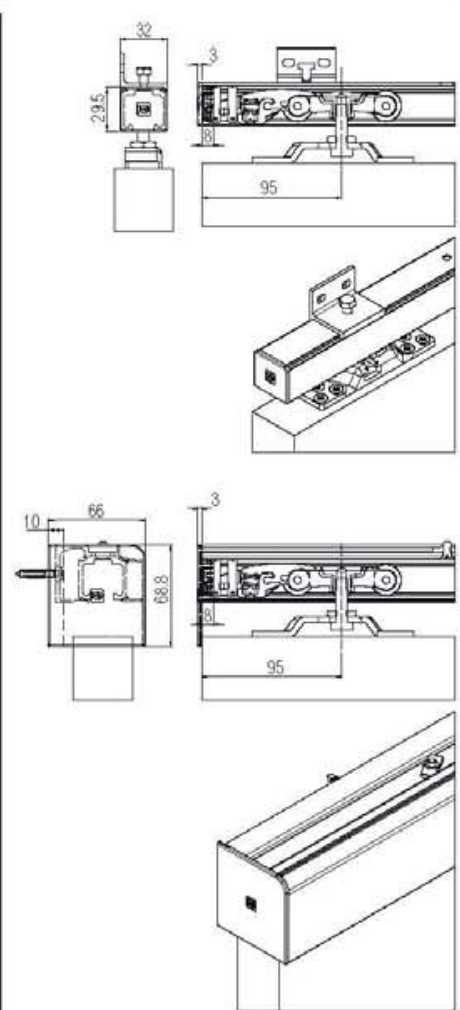
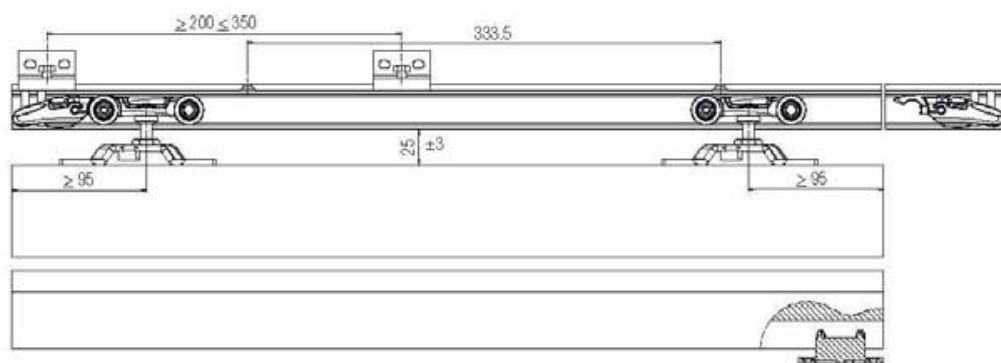
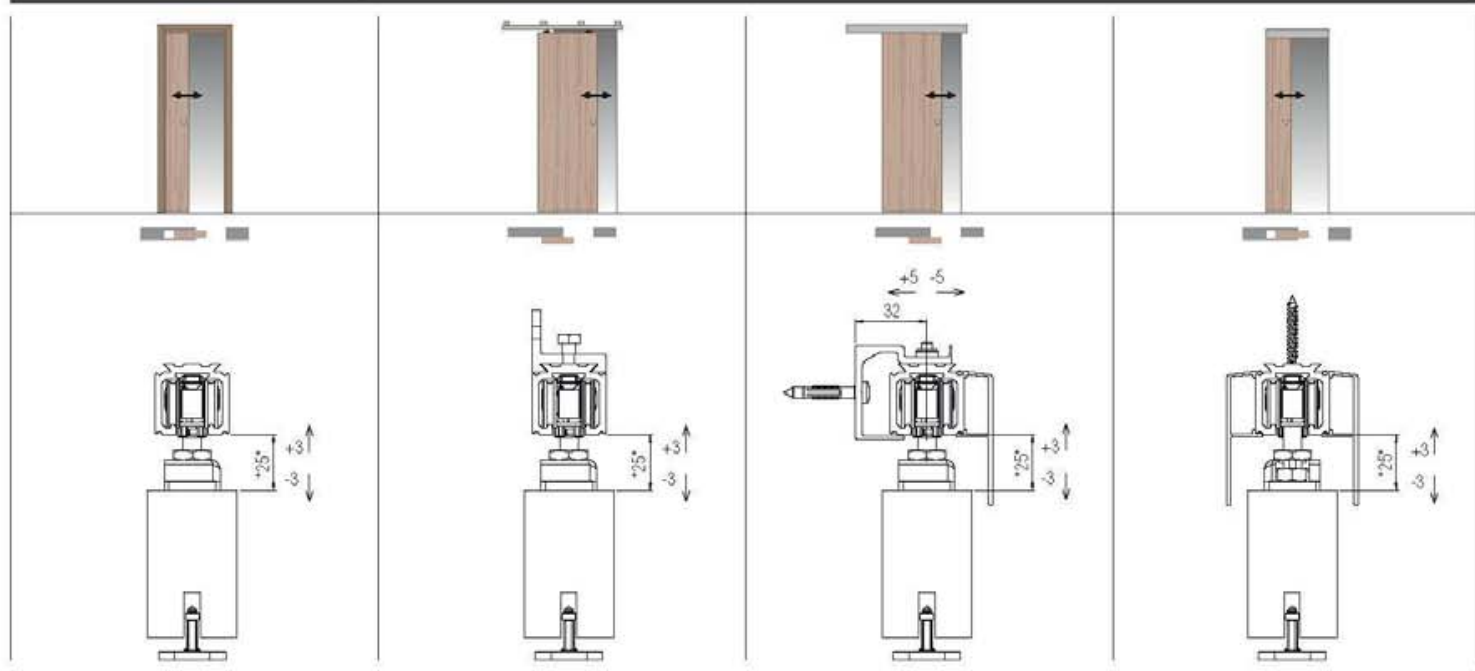

80 kg

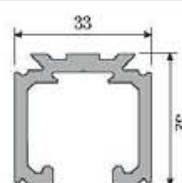

120 kg

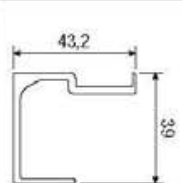

80 kg

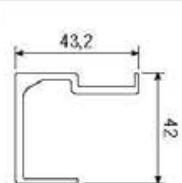

120 kg



80 kg

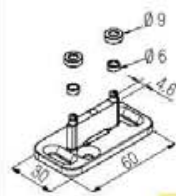
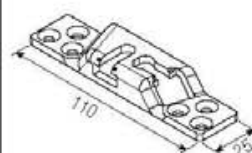

SYSTEM 0600/80/120

Soluzione per porta in legno scorrevole a filo del binario
 Solución para puerta corredera en madera a ras de la guía
 Solution pour porte coulissante en bois ras de mur

Patented
 Patentado
 Breveté

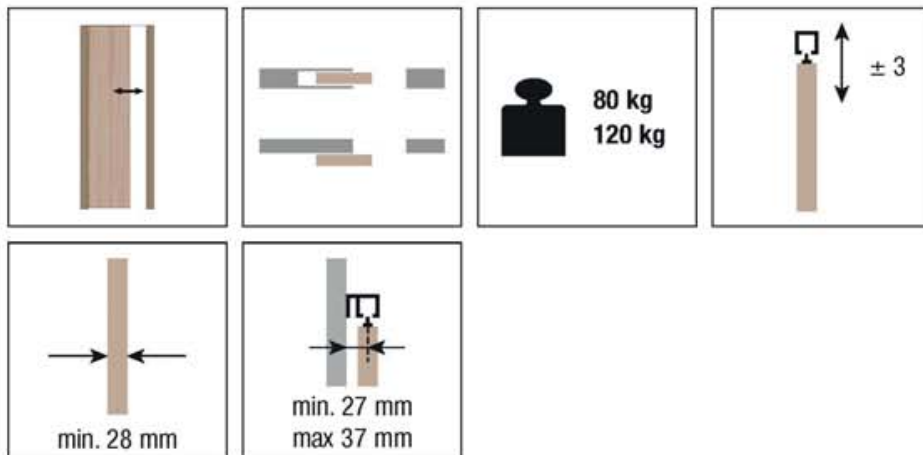

KIT Art. 0600 80

Carrello di scorrimento 80/120kg Carro de deslizamiento 80/120kg Chariot de coulissement 80/120 kg		2 pcs
Profilo ancoraggio porta Soporte anclaje puerta Profil d'ancrage de porte		2 pcs
Profilo ancoraggio carrello (Vite non inclusa) Soporte anclaje carro (Tornillo no incluido) Profil d'ancrage de chariot (Vis non-inclus)		2 pcs
Guida inferiore regolabile Guiador inferior regulable Guide inférieure réglable		1 pcs
Freno d'arresto Freno tope Frein de blocage		2 pcs
Tappo chiudi foro Tapa de cierre de mecanizado Bouchon cache trou		2 pcs
Tappo chiudi foro in sormonto Tapa de cierre de mecanizado superpuesta Bouchon cache trou en chevauchement		2 pcs
Chiave regolazione grano Llave regulación freno Clé de réglage du frein		1 pcs
Chiave regolazione profili Llave regulación Clé de réglage du profil		1 pcs

*Ricambi - *Repuestos - *Echanges

Art. 0500 52 Carrello di scorrimento 80/120kg Carro de deslizamiento 80/120kg Chariot de coulissement 80/120 kg		2 pcs
Art. 0600 51 Profilo ancoraggio porta Soporte anclaje puerta Profil d'ancrage de porte		2 pcs
Art. 0600 52 Profilo ancoraggio carrello (Vite non inclusa) Soporte anclaje carro (Tornillo no incluido) Profil d'ancrage de chariot (Vis non-inclus)		2 pcs
Art. 0500 13 Guida inferiore regolabile Guiador inferior regulable Guide inférieure réglable		1 pcs
Art. 0500 12 Freno d'arresto Freno tope Frein de blocage		2 pcs
Art. 0600 54 F Tappo chiudi foro Tapa de cierre de mecanizado Bouchon cache trou		2 pcs
Art. 0600 54 S Tappo chiudi foro in sormonto Tapa de cierre de mecanizado superpuesta Bouchon cache trou en chevauchement		2 pcs
Art. 0500 58 Piastrini di fissaggio + viti per profilo di aggancio a parete 0500 F Placas de fijación + tornillos para perfil de acoplamiento a pared 0500 F Plaque de fixation + vis pour profil de fixation au mur 0500 F		100 pcs

Accessori compatibili Accesorios compatibles Accessoires compatibles

Art. 0500 1 m 6 Art. 0500 300 m 3 Binario in alluminio forato e anodizzato 60/80kg Guía en aluminio perforada y anodizada 60/80kg Rail en aluminium anodisé et perforé 60/80kg		**Art. 0500 F 200 m 2 **Art. 0500 F 300 m 3 **Art. 0500 F 400 m 4 Fissaggio a parete 60/80kg Fijación a pared 60/80 kg Fixation à la cloison 60/80 kg	
Art. 0500 10 m 6 Art. 0500 10 300 m 3 Binario in alluminio forato e anodizzato 120kg Guía en aluminio perforada y anodizada 120kg Rail en aluminium anodisé et perforé 120kg		**Art. 0500 F 10 m 6 **Art. 0500 F 10 300 m 3 Fissaggio a parete 120kg Fijación a pared 120 kg Fixation à la cloison 120 kg	
Art. 0500 4 Attacco laterale 60/80kg Soporte de sujeción lateral 60/80 kg Fixation latérale 60/80kg		**Art. 0500 C 200 m 2 **Art. 0500 C 300 m 3 **Art. 0500 C 400 m 4 Profilo controsoffitto Perfil sujeción Profil faux plafond	
Art. 0500 5 Attacco laterale 120kg Soporte de sujeción lateral 120 kg Fixation latérale 120kg		Art. 0500 61 Chiusura laterale binario Cierre lateral guía Fermeture latérale rail	
		Art. 0500 62 Chiusura laterale fissaggio a parete Cierre lateral fijación a pared Fermeture latérale fixation à la cloison	

*Gli articoli presenti nella tabella "Ricambi" sono ordinabili solo nelle quantità indicate.

**Non compatibile con articolo 0500 4 e 0500 5.

*Los artículos presentes en la tabla "Repuestos" se pueden pedir sólo en las cantidades indicadas.

**No compatible con artículos 0500 4 y 0500 5.

*Les accessoires présents dans le tableau "pièces de rechanges" sont vendus seulement dans les quantités indiquées.

**Non compatible avec l'article 0500 4 et 0500 5.

Soluzioni scorrevoli realizzabili
Soluciones correderas realizables
Solutions réalisables avec portes coulissantes

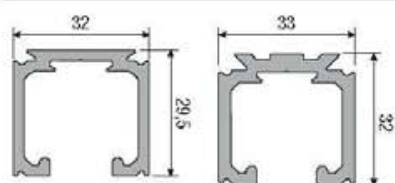
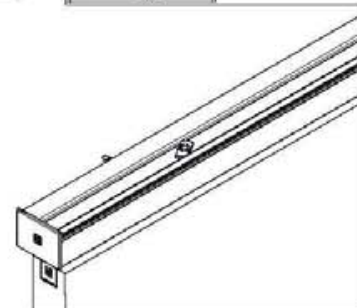
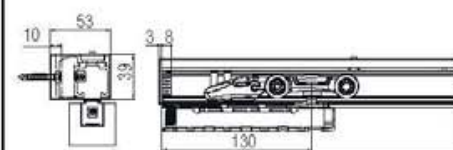
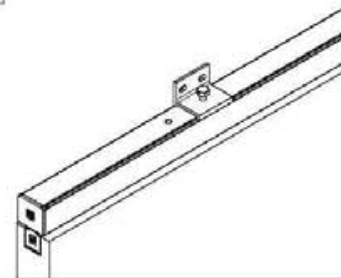
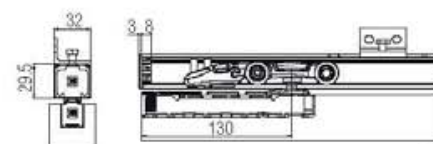
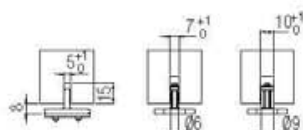
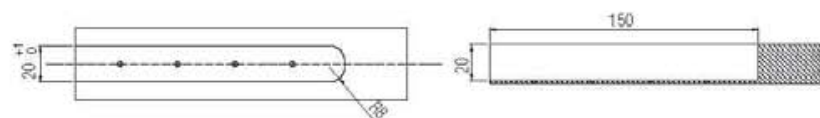
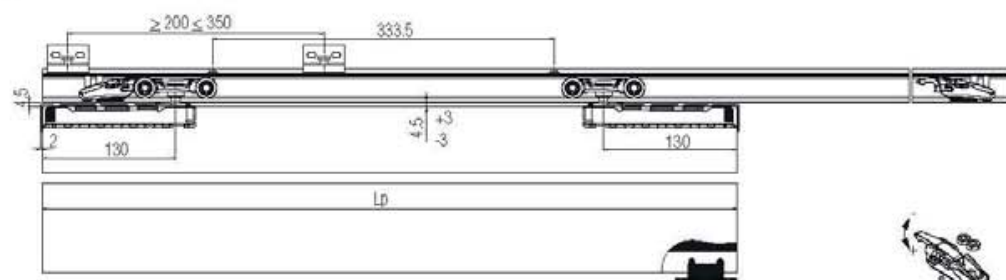
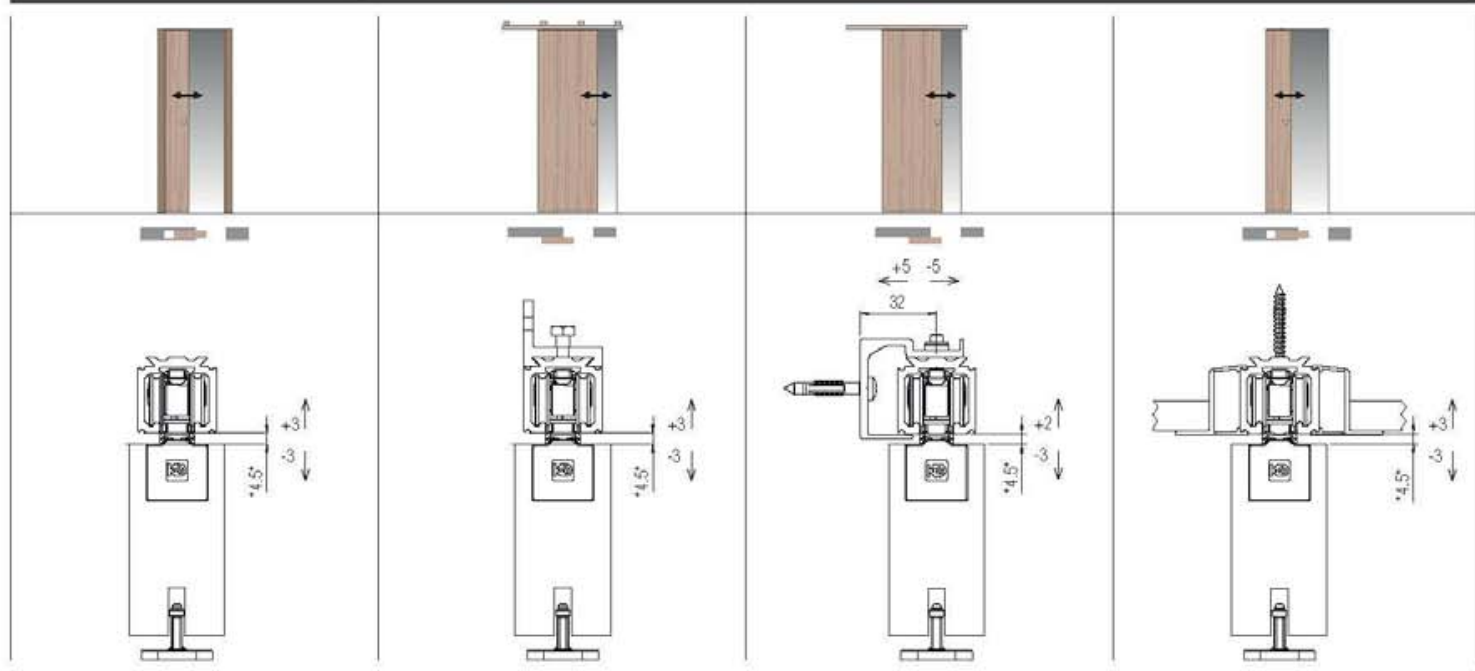

80 kg

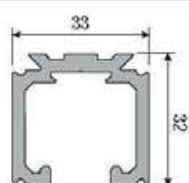

120 kg

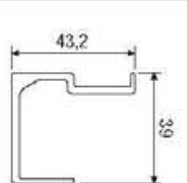

80 kg

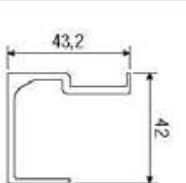

120 kg

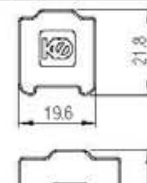
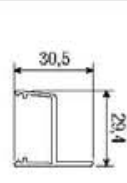

SYSTEM 2000

Sistema scorrevole per porte in legno
 Sistema corredero para puertas de madera
 Système coulissant pour portes en bois

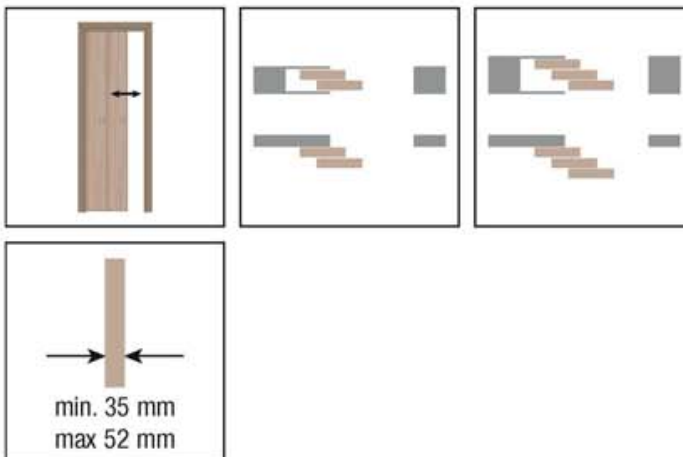

KIT Art. 2000

Guida inferiore regolabile Guiador inferior regulable Guide inférieur réglable	 1 pcs
Agganci superiori "A" Arrastre superior "A" Crochets supérieurs "A"	 2 pcs
Agganci superiori "B" Arrastre superior "B" Crochets supérieurs "B"	 1 pcs
Chiave regolazione freno Llave regulación freno Clé de réglage du frein	1 pcs

*Ricambi - *Repuestos - *Ricambi

Art. 2000 51 Guida inferiore regolabile Guiador inferior regulable Guide inférieur réglable	 1 pcs
--	--

Il System 2000 non può essere utilizzato con i System 0600

El sistema 2000 no puede ser utilizado con el sistema 0600

Le système 2000 ne peut être utilisé avec les systèmes 0600

*Gli articoli presenti nella tabella "Ricambi" sono ordinabili **solo** nelle quantità indicate.

*Los artículos presentes en la tabla "Repuestos" se pueden pedir **sólo** en las cantidades indicadas.

*Les accessoires présents dans le tableau "pièces de rechanges" sont vendus **seulement** dans les quantités indiquées.

Soluzioni scorrevoli realizzabili
Soluciones correderas realizables
Solutions réalisables avec portes coulissantes

